



Aufbau- und Verwendungsanleitung

(GB) Instructions for assembly

(PL) Instrukcja montażu

(HU) Felépítési és használati útmutató

(RU) инструкция по сборке

Version 2.0 © 2015 KRAUSE-Werk

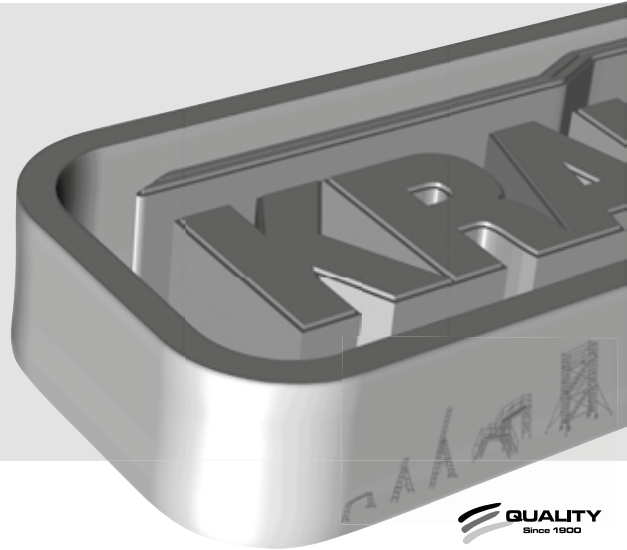

QUALITY
Since 1900

(DE) Stufen-Stehleiter mit großer Standplattform / und Sicherheitsbügel

(GB) Step ladder with steps and extra large platform / with safety bar

(PL) Drabina wolnostojąca z dużą platformą / - i barierkami zabezpieczającymi

(HU) Lépcsőfokos állólétra nagy dobogóval és kapaszkodókerettel

(RU) Стремянка с поручнями и большой площадкой / Стремянка с большой площадкой, поручнями и дугой безопасности



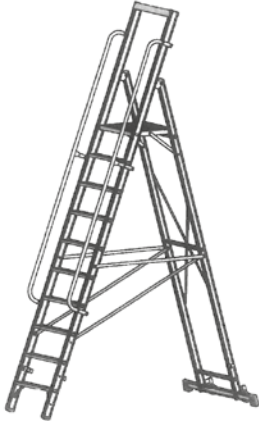

Certificate
EN 131
Norm

BG 1104



Art.-No.: 127761, 127778, 127785,
127792, 127808, 127822,
127846

Art.-No.: 127501, 127518, 127525,
127532, 127549, 127563,
127587

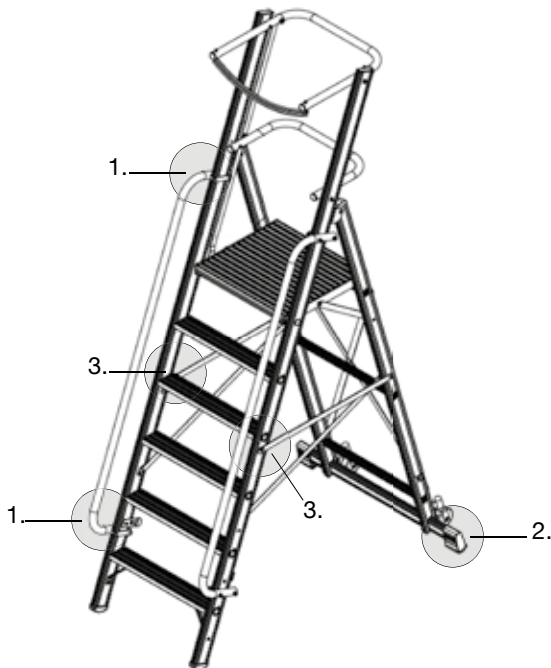

1.

- DE** Montage Handlauf
- GB** Assembling hand rail
- PL** Poręcz
- HU** Kapaszkodó felszerelése
- RU** монтажный поручень

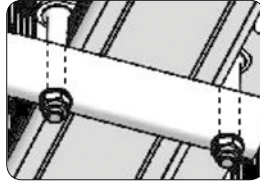
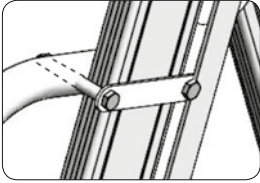

2.

- DE** Montage Traverse
- GB** Assembling stabilizer
- PL** Stabilizator
- HU** Alsó kitámasztó felszerelése
- RU** монтажная траверса

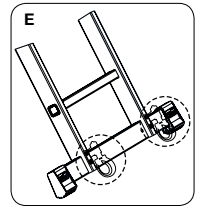
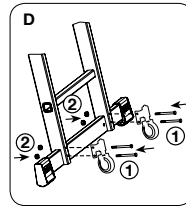
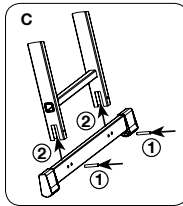
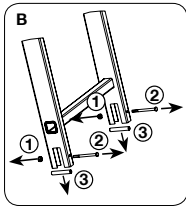
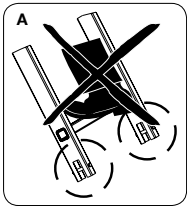

3.

- DE** Zug-/Drucksicherung
- GB** Compression-tension security devices
- PL** Blokada samoczynnego złożenia/rozłożenia się
- HU** Húzásra és nyomásra terhelhető
- RU** Распорный предохранитель

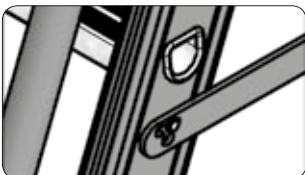



KRAUSE-Werk GmbH & Co. KG
Am Kreuzweg 3
D 36304 Alsfeld

Telefon: 06631 / 795-0
Telefax: 06631 / 795-139
www.krause-systems.com